

DC-DC /SOLAR BATTERY CHARGER Mounting Instructions and Operating Manual

Thank you for using our products, please read this product manual carefully before using the products

Model

DC12V→DC12V

MODEL	INPUT Voltage → OUTPUT Voltage	DC-DC Charger current	PV Charger current	Max. PV Power
B2B1230	12V→12V	12V/30A	—	—
B2B1260	12V→12V	12V/60A	—	—
BS123020	12V→12V	12V/30A	12V/20A	250W
BS126030	12V→12V	12V/60A	12V/30A	430W
BS126045	12V→12V	12V/60A	12V/45A	620W

DC12V→DC24V

B2B122425	12V→24V	24V/25A	—	—
BS12242530	12V→24V	24V/25A	24V/30A	820W

DC24V→DC24V

B2B242450	24V→24V	24V/50A	—	—
BS24245030	24V→24V	24V/50A	24V/30A	820W

DC24V→DC12V

B2B241260	24V→12V	12V/60A	—	—
BS24126050	24V→12V	12V/60A	12V/50A	685W

Function

This is a automatic DC-DC charger that can charge the main battery through the alternator and starter battery, or Solar panels charge the main battery (some models), DC-DC battery charger designed specifically for motorhomes, campers, ships, etc.

B2B Charge:

It means to charge the main battery through alternator and starter battery. If it is not used in the vehicle, you can also use one battery to charge another battery

1. When the vehicle is running, the vehicle alternator can quickly charge the main battery through the charger at full power
2. The charger can charge the main battery according to the specified voltage and current by boosting or stepping down to ensure that the main battery is in accordance with the standard. charging curve charging

MPPT Solar Charge

1. The charger can increase the charging efficiency of the solar panel by 10-30% through MPP technology (search for the maximum power point)
2. The charger can charge the main battery according to the specified current by boosting or stepping down to ensure that the main battery is charged according to the standard charge curve charging
3. When the vehicle is not used for a long time, you can maintain a small trickle charge flow for the starter battery to ensure that the starter battery has enough electricity to start the vehicle

Other functions

1. Fully automatic charging: In order to continuously charge the battery, the controller can always be connected to the car battery. When the charging energy is stopped, such as the car stops driving, the battery will not discharge in the reverse direction.
2. Multiple protection functions: with overheating, overvoltage, short circuit, wrong connection protection
3. External temperature sensor: The ambient temperature will affect the parameters for charging the battery. The controller needs to perform parameter compensation according to the temperature of the battery, especially in places with large temperature changes. It is strongly recommended to install a temperature sensor.

Note: Lithium batteries do not require temperature compensation

4. Lithium battery automatic wake-up function: When the lithium battery BMS is protected for some reason, the controller can automatically wake up the BMS and continue to charge the lithium battery

Battery life and efficiency

1. Ensure that the battery installation environment is ventilated and dissipated. The LiFePO4 battery is recommended to work in an environment above 0 degrees Celsius, otherwise the battery characteristics will drop a lot
2. The battery must be fully charged and stored, and it must be charged regularly to ensure that it is not stored under power, otherwise it will affect the battery life
3. Lead-acid batteries that are completely empty must be charged as soon as possible, otherwise it may cause permanent damage!
4. The lithium battery must have a BMS (Battery Management System). Try to avoid completely emptying the battery.

Connection

B2B series

- B2B12-12 series
- B2B12-24 series
- B2B 24-12 series
- B2B 24-24 series

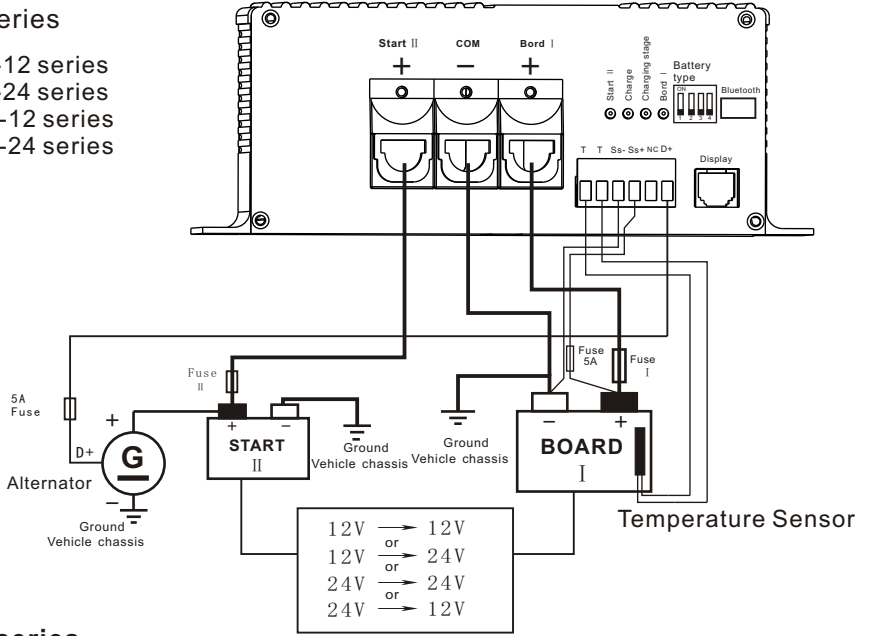

BS series

- BS 12-12 series
- BS 12-24 series
- BS 24-12 series
- BS 24-24 series

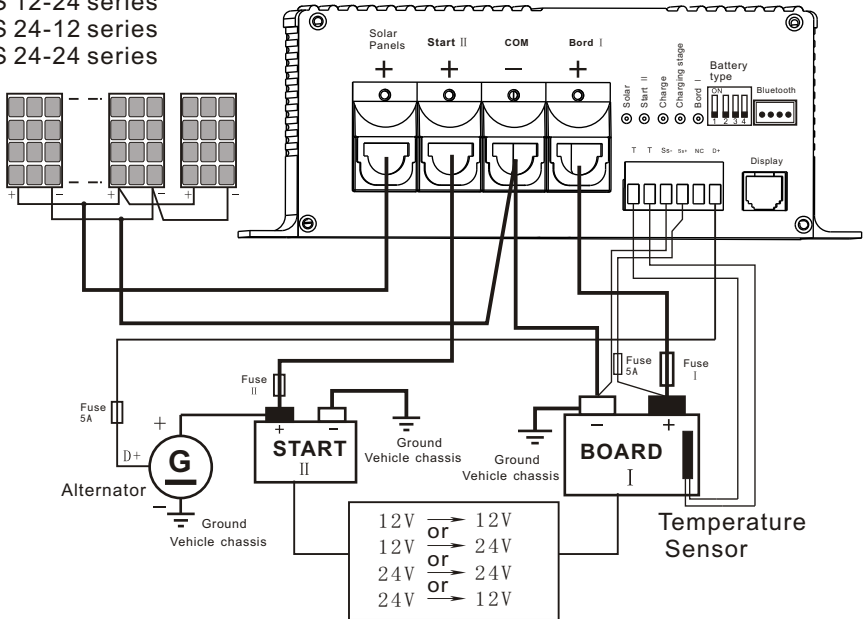

6 Pin terminal description

Pluggable 6P terminal set: In the case of limited space, the terminal can be pulled out at any time to facilitate the connection of the wire, and then re-insert it

Wire size: at least 0.75mm

"T-T" : The main battery temperature sensor connection terminal, the sensor can be connected at will regardless of the positive and negative poles. The temperature compensation value is: $-3\text{mV}/^{\circ}\text{C}/2\text{V}$. The temperature sensor is an optional accessory, if not connected, the controller defaults to the battery temperature at 25°C .

Note: Lithium batteries do not have temperature compensation

"Ss-, Ss+": Used to connect cables for accurately measuring the battery voltage, which helps the controller to more accurately determine the current battery Voltage. Compensate for the voltage loss on the charging cable. If the voltage sensor is not connected or the connection is interrupted, It will switch to the normal operation of the measurement program with the charging cable, which does not affect the normal operation of the charger. If there are multiple batteries To use in parallel, connect SS- to the negative terminal of the first battery, and connect SS+ to the second or last battery The positive pole

"D+" B2B charging control signal, connect "D+" directly to the D+ signal output terminal of the alternator. If there is no D+ signal in alternator, the "D+" can be directly connected to the car ignition switch ON signal to Instead of the D+ signal on the alternator, if the D+ terminal is not connected, the B2B charging will not work

"NC" No function

Temperature sensor (RTS)

Connect the temperature sensor to the "T T" port, and connect the other end to the main battery to measure the real-time temperature of the main battery, ensure the temperature the connection position of the sensor is not interfered by any heat source (including motor heat, exhaust gas, heater, etc.), when the temperature sensor is not connected Or when the temperature sensor is disconnected, the controller will automatically switch to the default 25°C . The lithium battery has no temperature compensation function, so there is no need to connect a temperature sensor.

NOTE: If the 0°C charging function is required, the temperature sensor must be connected

Lithium battery 0°C charging function







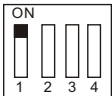
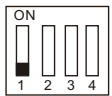

DIP switch No. 1 is used to select whether the lithium battery needs to be charged at 0°C

select "ON", it means stop charging below 0°C, select "OFF" means below 0°C allow charging

NOTE: The external temperature sensor must be connected

SWITCH	0°C charging	Description
	NO	Temperature < 0°C, stop charging Temperature > 3°C, Resume charging
	YES	Temperature: -20°C ~ 0°C, Reduce current charging Temperature: > 3°C, Resume normal charging

Battery selection

SWITCH	Battery type	Boost voltage 12V/24V
	GEL	14.3V/28.6V
	Sealed battery	14.4V/28.8V
	Flooded/AGM	14.7V/29.4V
	LiFePO4	14.4V/28.8V
	Lithium-ion(NCM)	12.6V/25.2V
	LiFePO4	13.9V/27.8V
	LiFePO4	14.2V/28.4V
	LiFePO4	14.6V/29.2V

Description

Dip switch number 2, 3, 4 to select batteryType <see left table>

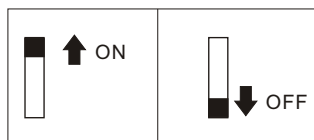

⚠ Warning

1. Before the product is used, it must be selected correctly battery type, wrong battery type may cause the battery to be broken
2. Lithium batteries must have BMS, otherwise charging is not allowed
2. It is not allowed to change the battery type during the charging process, If necessary, the charger must be powered off

Charging parameters

Battery type	Equalizing	Boost	Float	HVD	LVD	Constant voltage charging time
GEL	-	14.3V	13.8V	15.5V	11V	2h
Sealed	14.6V	14.4V	13.5V	15.5V	11V	2h
Flooded/AGM	14.8V	14.7V	13.5V	15.5V	11V	2h
LiFePO4	-	*14.4V/13.9V 14.2V/14.6V	13.8V	15.5V	11V	2h
Lithium-ion (NCM)	-	12.6V	12.5V	13.5V	9.3V	2h

- Remarks:** 1. * The data is determined according to the battery type
 2. The above data is 12V battery data, if the main battery is 24V, all parameters need to be multiplied by 2.

LED lamp

LED	Name	Color	Stats
L1	Board I	Red	Short flashing: Voltage is normal (1time/ 5 s) Fast flashing: Over-voltage(HVD) (1time/ 1 s) ON: Low-voltage(LVD)
L2	Battery full	Green	Off: No charging Short flashing: Boost charging stage (1time / 5S) Fast flashing: Constant voltage stage (1 /1S) ON: Battery full
L3	Charge	Yellow	Off: Not charging Short flashing: Lithium battery does not charge below 0°C (1time/2S) Fast flashing: Over-heat inside the controller (1 time/S) ON: Charging (B2B charging or PV charging) Slow flashing: Reduce current charging (battery temperature >50°C or <-20°C) (4s ON and 1s OFF)
L4	Start II	Green	Off: No D+ signal, no charging Flashing: Start battery voltage < 11V (1 /5S) (B2B mode: <10.8 stop charging, >12.5V, resume charging) Fast flashing: Start battery voltage >16V, (1time/S) ON: Start battery voltage is normal (11V-16V) Remarks: 24V battery, parameter value needs to be multiplied by 2

Code	Name	Color	Stats
L5	Solar	Green	OFF: B2B mode Short flashing: PV voltage <Board battery voltage (1time / 5s) Fast flashing: PV voltage >50V (1 time/ 2 s) ON: PV voltage is normal

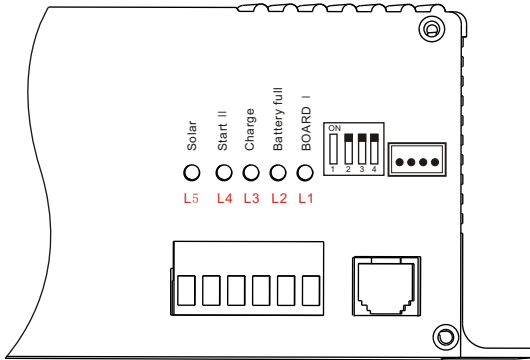

Charging process

1. Boost charge stage: Charge according to the maximum current until the battery voltage reaches the boost voltage. Boost voltage refer to charging parameters.
2. Constant voltage charge stage: When the battery voltage rises to the boost voltage, the charging current begins to drop, constant voltage charging time is 2hours.
 - When the battery is first charged, the voltage >12.6V, Charge without constant voltage for 2 hours, directly float charge
3. Float charge stage : Low current to maintain float voltage

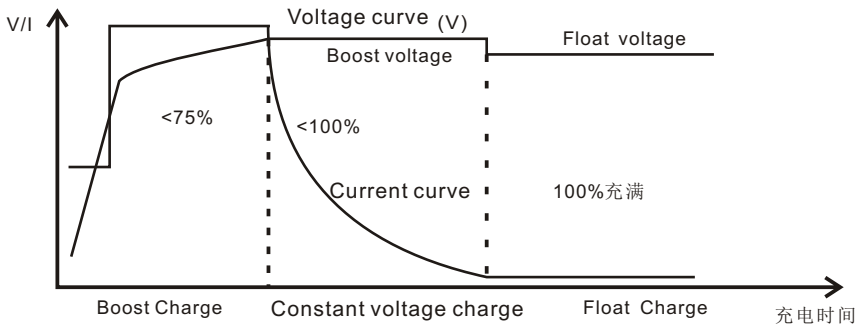

Protection

Board battery over-voltage	<ul style="list-style-type: none"> ● Battery voltage > HVD, Charge off ● Battery voltage > boost charge voltage +0.2V, continuous 10 seconds, charge off ● Buzzer alarm: Di-Di-Di, continuous 1 minute
Board battery Low-voltage protection(LVD)	<p>Battery voltage < LVD</p> <p>Buzzer alarm: DiDi-DiDi-DiDi, continuous 1 minute</p>
Starter battery low-voltage	<ul style="list-style-type: none"> ● 12.3V-10.8V(12V)/24.6V-21.6V(24V) Reduce charging current ● <10.8V(12V)/21.6V(24V), B2B stop charge
PV over-power (Only BS series)	Solar panel limit Max.power
PV over-voltage(Only BS series)	<p>PV voltage > 50V. PV charge OFF</p> <p>Buzzer alarm: DiDiDi-DiDiDi, continuous 1 minute</p>
B2B charge, over-power protection	Limit the maximum charging current and maximum power (current and power view Model specification table)
Reverse protection (Battery, Solar, Start battery)	<ol style="list-style-type: none"> 1. Board battery reverse : Blown fuse 2. Start battery reverse: Blown fuse 3. Solar reverse: No effect, self-damage increased
Overheating protection /Restore	<ul style="list-style-type: none"> ● temperature > 85°C: Stop charging, Drop to 60 °C: resume charging. ● temperature > 75°C, Reduce current charging <p>The temperature returned to 65°C, returned to rate current charging</p> <p>Buzzer alarm: DiDi-Di-DiDi-Di, continuous 1 minute</p>
System voltage error	<ul style="list-style-type: none"> ● 12V battery > 16V ● 24V battery > 32V ● Buzzer alarm: DiDiDi-DiDiDi-DiDiDi, 1 minute

Parameter

	B2B1230 BS123020	B2B1260 BS126030/45	B2B122425 BS12242530	B2B242450 BS24245030	B2B241260 BS24126050
Main battery "BOARD I "					
Lead-Acid, Gel, AGM Batteries Nominal Voltage	12V	12V	24V	24V	12V
LiFePO4 Nominal Voltage	12.8V	12.8V	25.6V	25.6V	12.8V
lithium-ion (NCM) Nominal Voltage	11.1V	11.1V	22.2V	22.2V	11.1V
Capacity (Battery Size), recommended:	45-280AH	100-520AH	45-280AH	100-520AH	100-520AH
Battery voltage range	8V-16V	8V-16V	16V-32V	16V-32V	8V-16V
Vehicle Starter Battery "Start II":					
Vehicle Starter Battery Nominal Voltage:	12V	12V	12V	24V	24V
Capacity (Battery Size), recommended:	60AH	80-100AH	60AH	80-100AH	80-100AH
B2B Charging operation					
Start battery voltage range	10.5-16V	10.5-16V	10.5-16V	21~32V	21~32V
Max. charge power	390W	780W	650W	1300W	780W
Max. charge current	30A	60A	25A	50A	60A
"D+" signal voltage	8-16V	8-16V	8-16V	16-32V	16-32V
MPPT solar charge controller (only BS series)					
Max. PV power	250W	430W/620W	820W	820W	685W
Max. PV charge current	14A	24A/35A	24A	24A	40A
Max. Open circuit voltage	50V	50V	50V	50V	50V
Board I Max.charge current	20A	30A/45A	30A	30A	50A
PV charges the start battery	0-5A	0-5A	0-5A	0-4A	no function
Temperature compensation	-3mv/°C/2V	-3mv/°C/2V	-3mv/°C/2V	-3mv/°C/2V	-3mv/°C/2V
"TR"signal	12V/1A	12V/1A	NC	NC	NC
Main battery temperature sensor"TT"	YES	YES	YES	YES	YES
Main battery voltage detection" SS-,SS+"	YES	YES	YES	YES	YES
Stand-by current	30±2mA	32±2mA	16±2mA	16±2mA	32±2mA
Weight	1.44kg	1.44kg	1.6kg	1.6kg	1.6kg
Operating temperature	-20-50°C	-20-50°C	-20-50°C	-20-50°C	-20-50°C
Dimension	190×194×70mm		190×215×70mm		
Optional accessories	Meter(MT-2) Bluetooth Dongle(BT10) Temperature sensor (TRS)				